



Getting Started

Grid Pad Pro 18

Looking after your Grid Pad

When not in use, store your Grid Pad safely with no hard objects rested or pressed against the screen.

Cleaning

The best way to clean the touchscreen is using a microfibre cloth. To minimise the risk of bacteria being transferred between users, the machine should be regularly cleaned with a detergent wipe.

This can be followed with an alcohol-based wipe after cleaning with the detergent wipe for a deep clean.

The machine should not be immersed in water, or cleaned with a wet cloth, gels, polishes or any abrasive cleaning product.

Protection

Avoid exposure to water, including heavy rain. The screen seal will protect it against moisture but the device is not designed to be waterproof.

Your Grid Pad is sufficiently robust for normal use but is not designed to be stood on or dropped from a height, so take care when handling and using to avoid drops and bangs.

Turning on your Grid Pad

Turn on the Grid Pad by pressing the power button on the right hand side of the device:

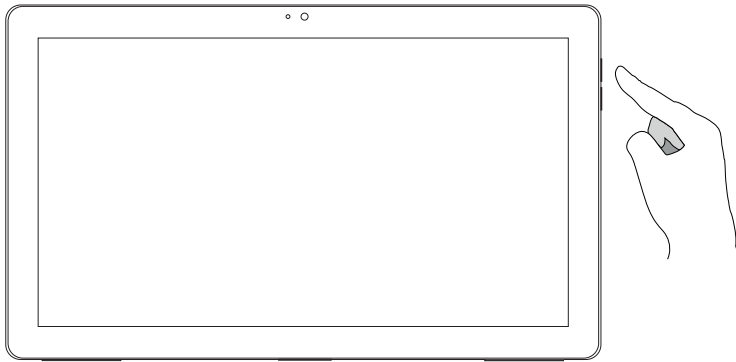

Charging your Grid Pad

To charge your Grid Pad, insert the charging cable to a power source and insert into the device as shown below.

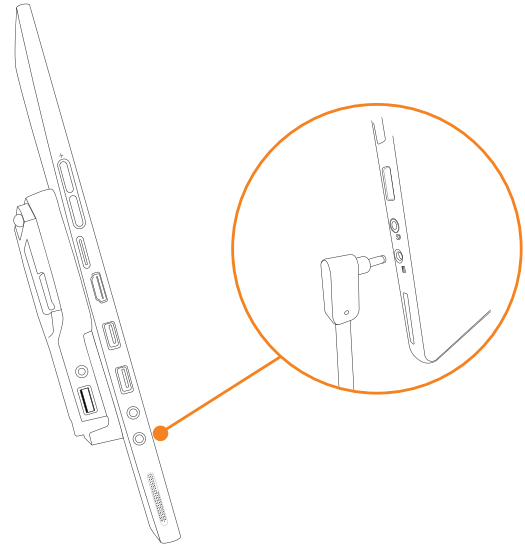

What is included with your Grid Pad

- Tablet computer with Windows
- Grid 3 software for communication and computer control
- High quality amplification
- Headphone socket for auditory scanning
- Switch input
- Infrared environment control
- Radio environment control
- Mounting plate to work with Rehadapt or DAESSY systems

All of the adaptations are connected by USB and will work when you turn your device on.

Auditory feedback and headphones

You can use headphones with your Grid Pad for private listening. This is particularly useful for switch users that want to hear what a selection will say before they select it. You need to set this up in Grid 3 and then plug your headphones into the Grid Pad as shown below:

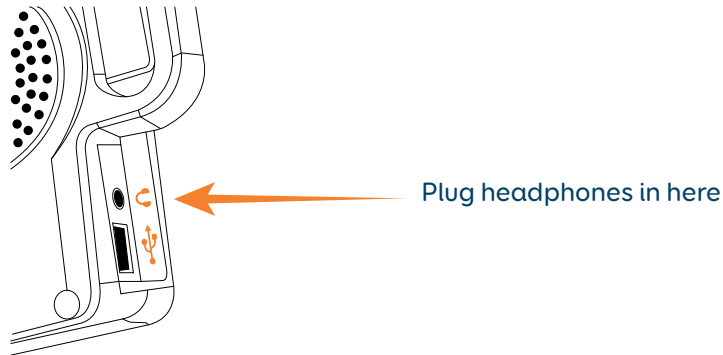

To setup auditory scanning in Grid 3

Open Grid 3 and go to **Settings > Speech > Audio feedback**.

Select 'Use right channel only'.

The audio channels will be split as required.

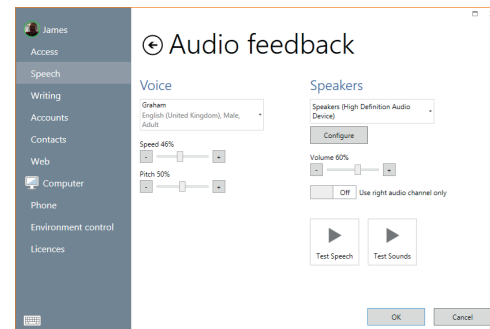

Switch input

You can plug up to two switches into your Grid Pad. The ports are clearly labelled 1 and 2. Your switches must have the standard 3.5mm jack connection.

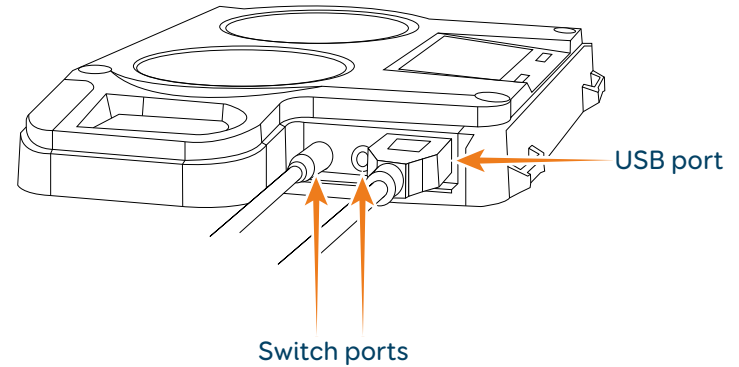

Mounting your Grid Pad

The Grid Pad is fitted with a mounting plate designed to work with Daessy and REHAdapt mounting systems.

Mounting safety

It is important to mount your device safely. Failure to do so could result damage to the device. Please read the safety information that will come with the mounting equipment you use.

Our devices are supplied with a special dual mounting plate, as shown in the picture.

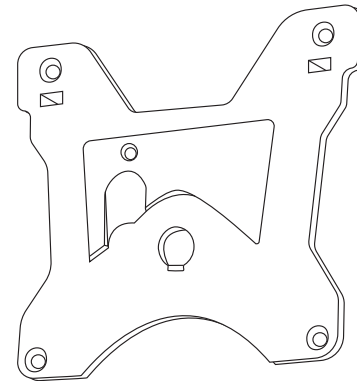

Mounting guidance

We recommend a number of precautionary measures when mounting your device:

1. Ensure that any staff or helpers who mount or demount the device are familiar with the mounting system, in particular the locking mechanism that prevents the device from being knocked off the mount.
2. The mount and the plate on the device should be inspected regularly to ensure that they are in good condition, and that no screws or fixings have worked loose.
3. If mounting on a wheelchair, make sure that there is no risk that the weight of the device could destabilise or unbalance the wheelchair.
4. If the device is mounted above the user (for example, an over bed mounting) a separate risk assessment should be carried out to ensure that there is no danger of the device falling onto the user.

Battery guidance

Getting the most out of your battery

The Grid Pad Pro 18 battery will last an average user 4 hours. Every user will use the device in a different way. Intensive use including using Bluetooth, streaming video and listening to music for long periods of time will use the battery faster. To improve the life of the battery:

- Reduce the brightness of the screen.
- Switch off connectivity if not being used such as Wi-fi and Bluetooth.
- Try not to run too many background tasks, particularly online services that sync such as OneDrive and Dropbox
- If appropriate use **Settings > Power and sleep** to adjust when the screen will switch off and the device will power down.

Charging guidance

Our batteries take between 2-5 hours to charge. To prevent degradation, it is good practice to allow the battery to charge completely. It is also recommend to allow the battery to completely run down every 3 months before charging completely. This is called a full cycle.

Battery degradation

The Grid Pad Pro has a lithium ion battery, as found in mobile phones, laptops and other portable devices. Over time the battery performance will degrade. If used correctly the battery it will degrade by approximately 10% after 250 cycles. If a device is charged every day for a year you would expect to see a degradation of approximately 15%.

Radio switches

It is also possible to connect switches wirelessly to the Grid Pad using a wireless switch transmitter (sold separately). If you order the transmitter with the device then it will be paired and ready to use.

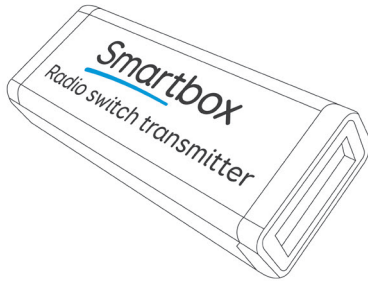

Radio switch reset button

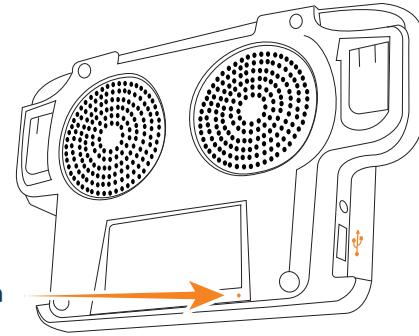

If you need to use your radio switch close to other users, you can change the channel to stop interference. To change the channel, open the transmitter as described in the radio switch manual.

1. Change the transmitter channel by setting the rotary switch to 2, 4 or 6 (different to other transmitter modules).
2. Clear the previous setting by pressing the radio switch reset button for 10 seconds, using a fine point such as a paper clip.
3. Connect a switch to socket 1 on the transmitter and keep it pressed while momentarily pressing the push button on the receiver.
4. Repeat with a switch connected to socket 2 on the transmitter
5. Reassemble the case.

Environment control

Infrared

Infrared environment control can be trained to work with most household devices that have an infrared remote control. This typically includes TVs and video systems, music centres and much more.

To create a cell in Grid 3 that can control an infrared accessory, we advise you refer to the software manual. However, to make a simple cell to complete this action:

1. In Grid 3, enter 'Edit mode' then double click on the cell you want to control the signal.
2. Choose Environment control from the Create cell menu.
3. Choose the type of accessory you would like to control, then select the **Action**. Click **Ok** to create the cell.
4. Under the Command menu select learn and follow the on screen instructions. Note if you are asked to configure the transmitter, choose **GEWA**.

See the diagram for the location of the infrared learning window on your Grid Pad.

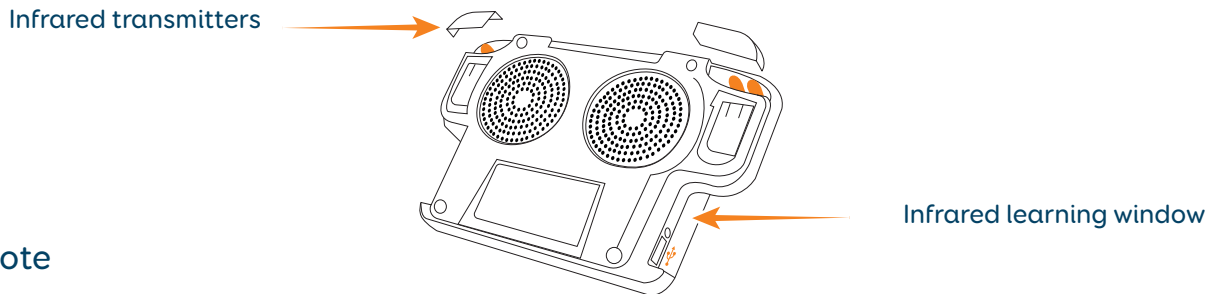

Safety note

This unit is designed for environment control. For safety critical functions, such as to call for help or to open the door to leave the building in an emergency, or for any other function on which your safety depends, you should consider the use of a simple environment control transmitter, such as the GEWA Prog, or a single action controller as a backup.

Radio control

Your Grid Pad contains a radio transmitter that can be used to control a range of accessories. These include mains sockets (and therefore lamps, fans and heaters) as well as alarms and intercoms. Setting up your Grid Pad with a remote socket varies depending on the make, the following example shows how an Easywave socket can be paired with a Grid Pad running the Grid 3 software.

Programming a socket:

1. Plug the socket into the mains.
2. In Grid 3, enter edit mode and create a new cell and insert the command **EasyWave**. Choose the code you wish to transmit (**Button 1 A** if this is your first socket)
3. Press the **programming button** on the socket once. The LED will flash steadily.
4. Click 'Transmit now'.
5. The LED on the socket will now be solid for a few seconds before flashing again. Press the **programming button** three more times to confirm the pairing.
6. Exit edit mode in Grid 3 and select your cell. It should turn the socket on.
7. To create an 'off' cell repeat the process but choose **Button 1 B** and press the button on the socket twice when learning for the first time.

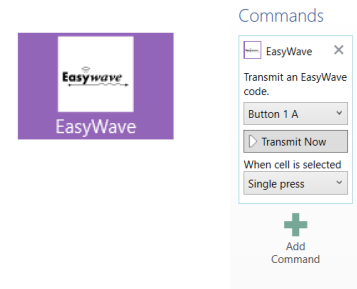

Programming button

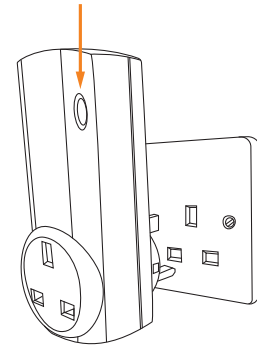

Specification

Processor	Intel® Pentium™ Quad Core N3700 1.6 GHz
Memory	8GB
Hard drive	500GB
Graphics card	Intel® HD Graphics
Dimensions (mm)	440 x 325 x 50
Camera	2 MP front
Screen	17.3" 1080 Full HD Display
Connectivity	Wi-fi and Bluetooth
Ports	2x USB 2.0, speaker out, Micro SD card slot
Switch access	2 x 3.5mm jack
Amplified speaker	2 x built-in high quality speakers
Environment control	Gewa, Eldat, Z-wave

Warranty

Grid Pad devices are covered under the standard warranty for 2 years.

Repairs

Please do not attempt to open your Grid Pad, as there are no user serviceable parts inside. If you want to discuss a repair please contact your local reseller.

For more information visit www.thinksmartbox.com.

Statement of compliance

This apparatus complies with the requirements of directive 93/42/EEC concerning medical devices. This Product is subject to Directive 2002/96/EC of the European Parliament and the Council of the European Union on waste electrical and electronic equipment (WEEE), and should not be disposed of as unsorted municipal waste. Please utilise your local WEEE collection facilities in the disposal of this product.



Smartbox



US Office

Smartbox Assistive Technology Inc
2831 Leechburg Road
Lower Burrell
Westmoreland
PA
15068-2539

UK Office

Smartbox Assistive Technology Ltd
Smart House, 4a Court Road
Malvern, WR14 3BL, UK

+44 (0) 1684 578868
info@thinksmartbox.com

www.thinksmartbox.com